

# Massage Bathtub

## Instructions of Installation and Use

### Cleaning&Maintenance

1. During the transportation or installation, do not pull the pipe or hold accessories to avoid the water leakage.
2. After long time use, if there are some dirt on product's surface, wipe it off gently by a soft towel stained with mild detergent; for the metal parts, polish it with some car wax by a towel, which brings out a refreshing appearance.
3. Scale deposit can be wiped off with warm citric acid or vinegar by a soft cloth.
4. Don't clean the tub and accessories with hard or coarse material to avoid any scratches.
5. Don't clean the tub and accessories with gasoline to avoid any damages.
6. It is not recommended to leave water in the tub for a long time or use this tub for washing purpose. Pls drain off the water after the bath and disconnect the power supply.
7. There should be sufficient power supply and wires should be safely grounded.
8. For your safty, a professional technician is necessary to ensure earthing wire be well grounded and a RCCB fitted during installation.



MT-RT1803E

# Preparations

Dear Customer,  
Thank you for choosing our product. For your safe concern, please take a few minutes to read this manual before installation and use.

## WARNING

1. For a person who has heart trouble, high blood pressure & sugar diabetes should not take a steam shower or bath when feeling sick. (The kid is suggested to be accompanied by an adult when taking a bath)
2. Don't take a bath alone after drinking wine with alcohol or excess sports.
3. The water temperature should be below 45°C during shower and the recommended temperature is 30°C-38°C.
4. Don't take a bath for a long time. Recommended time: 15-21minutes.
5. All the information in this instruction are subject to change without prior notice.
6. Settings, configurations and details of the products are subject to be changed or upgraded without prior notice.
7. For the maintenance, please contact the technicians appointed by the dealer and don't disassemble and fix by yourself, or the supplier will be free from any consequences that may occur.

## CONTENTS:

Preparations	Page2
Installation Process	Page4
Instruction of Using Our Products	Page8



Please make sure all accessories are in the package  
(Bathtub 1set Accessory box 1pc Pillow 1pc)

Pillow

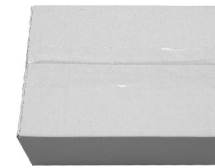

Accessory box :  
Faucet 1 pc  
Shower head 1pc  
Drain plug 1pc  
Drainer tube 1 pc



## Installation Tools:(no included)



Tape measure



Open spanner



Adjustable spanner



Thread sealing tape



Gradient

## Preparations

Install 2 water supply holes (one for cold and another for hot), 1 electrical outlet, 1 drain hole (diameter  $\geq 5\text{cm}$ ) in advance. Do as the pic. shows:

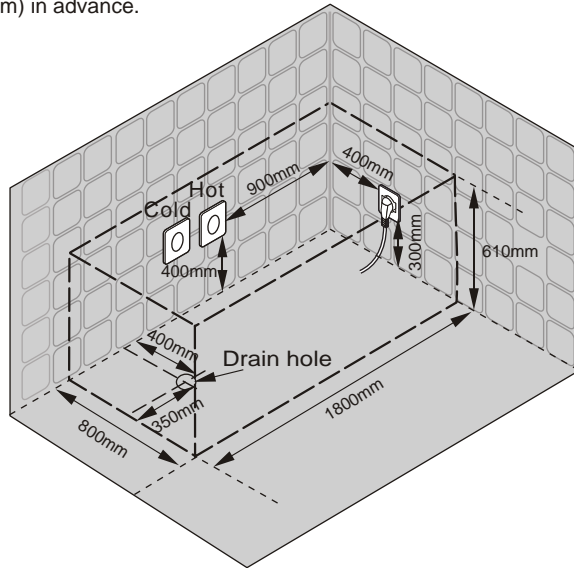

MODEL: MT-RT1803E

SIZE: 1800mmX800mmX610mm

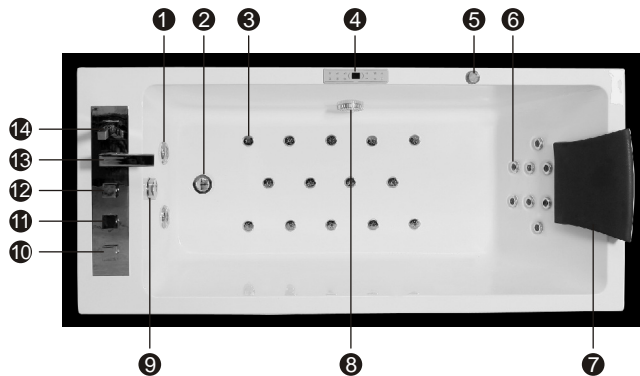

- ① 2-Big Jets
- ② Drainer
- ③ 14-Air Jets
- ④ Control Panel
- ⑤ Regulator
- ⑥ 8-Small Back Jets
- ⑦ Pillow
- ⑧ Water Circulation
- ⑨ Drainer Switch
- ⑩ Cold Water Handle
- ⑪ Hot Water Handle
- ⑫ Switch Handle
- ⑬ Faucet
- ⑭ Shower Head

## Installation Process



1. Open the accessory box 1 and take out the faucet as pic shows.

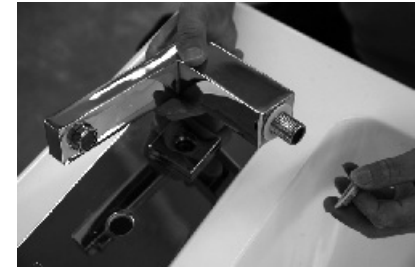

2. Remove the screw of inlet faucet.



3. Put the inlet faucet into the hole of the bathtub.



4. Put the rubber from below, and use spanner to screw it.



5. Distinguish the water pipes of faucet. Use spanner to screw the tie in.

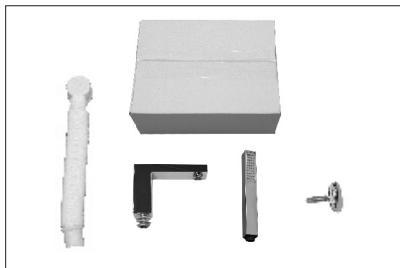

1. Open the accessory box 1 as pic shows.

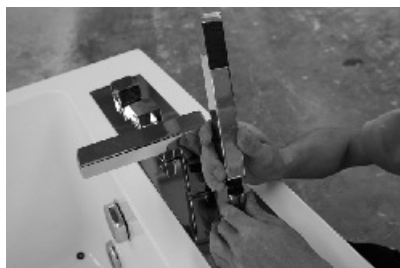

2. Put the shower head into the bathtub in right position as pic. Shows.

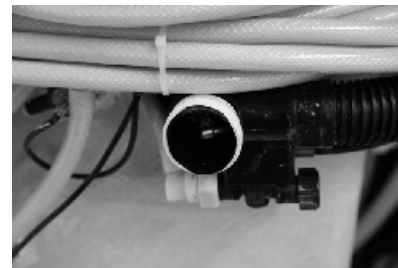

7. Make the thread sealing tape smooth.

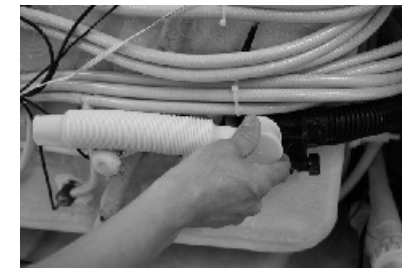

8. Fasten the drain tube.

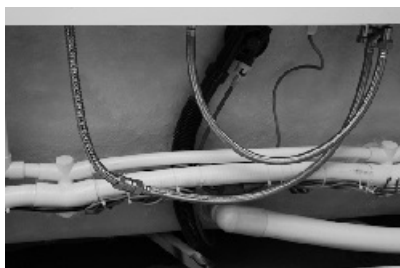

3. Distinguish the shower hose.



4. Screw it.

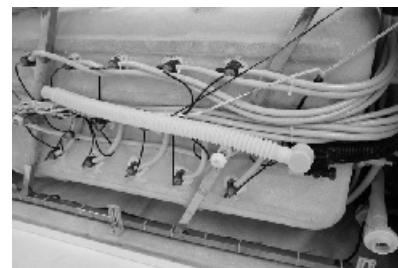

9. Put downcomer into the drain hole on the ground.

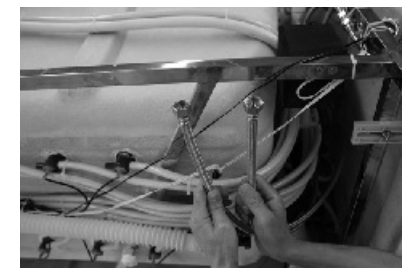

10. Connect the cold and hot water pipes .  
( These 2 pipes are not contained in the package,pls prepare by yourself)

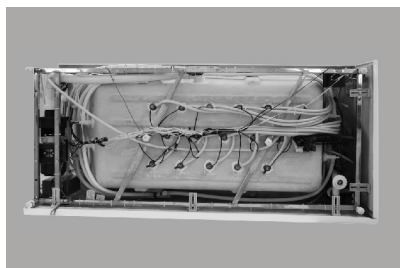

5. Side up the bathtub, then install downcomer.



6. Use thread sealing tape to wrap around the drain hole.



11. Put plug into the drain hole.



12. Install pillow.

13. Seal the barhthtub edge by silicon glue as follows.

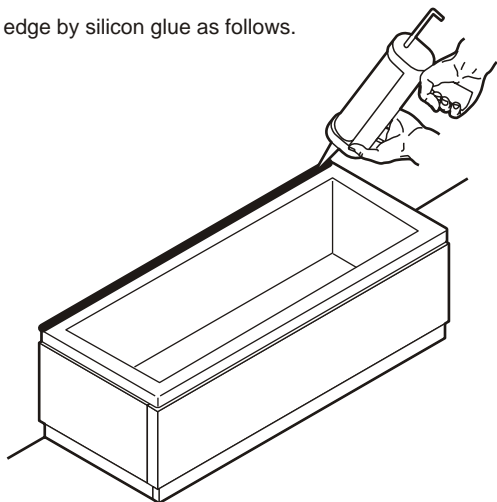

Unique Point:



1. The creepage protector will automatically cut off the circuit if the current is too high.

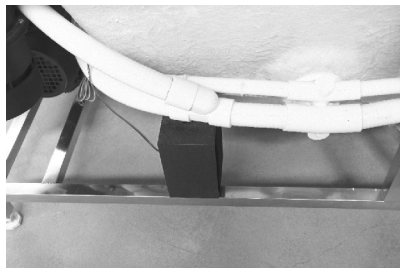

2. Stereo speaker.



3. Volume control.

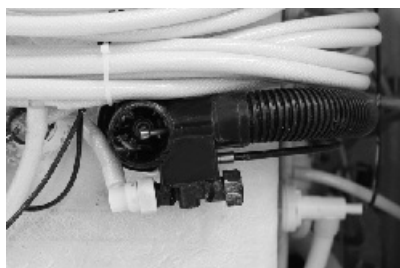

4. Waste water free piping system.

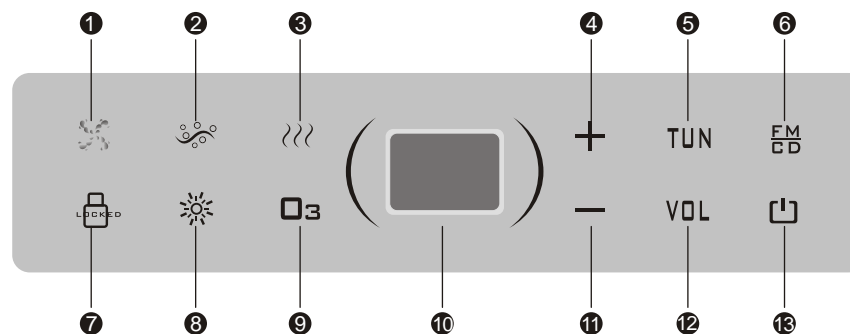

- ① Water Pump
- ② Bubble
- ③ Heater
- ④ Volume Up
- ⑤ Search Channel
- ⑥ FM/CD
- ⑦ Unlock
- ⑧ Lamp
- ⑨ Ozone
- ⑩ LCD Display
- ⑪ Volume Down
- ⑫ Volume
- ⑬ On/off

Run Condition ( Technology Parameter)

Character:

Rated voltage: AC 220V-240V  
 Rated current: 13.6A  
 Insulated resistance: >20MΩ  
 Rated frequency: 50Hz-60Hz  
 Rated power: 3000 W  
 Waterproof grade: IPX4

Technical Parameter:

Load type	Rated load voltage	Rated load frequency	Rated power	Others
Heater	AC 220V	50HZ	1500W	
Water pump	AC 220V	50HZ	750 W	
Bubble	AC 220V	50HZ	300W	
Light	AC 12V		20W	
Ozone	AC 12V		5W	
Sound			8Û/10W	

Size of Control Box:

Controller 210mm×48mm×45mm (l×w×h)  
 Generator 215mm×125mm×60mm (l×w×h)

## Function Instruction

1. On/off  
when power-up state, press any key the back lamp of the control panel is semi-light, press (L) to start the system, the back lamp is full light, all functions are open, the screen issues blue light, and display the current temperature, repress to close all functions.
2. Lamp  
Press (☀) to turn on/off the lamp.
3. Ozone  
Press (O3) to turn on/off the ozone.
4. Air pump  
Press (☁) to turn on/off the air pump.
5. Water pump  
Press (💧) to turn on/off the water pump when it is full of water.  
When lack of water, press (💧), there water pump will not start and it displays (⚡) on the screen. When plenty of water is filled, the pump start and it displays (💧) on the screen.
6. Heater  
Press (???) to turn on/off the heater when it is full of water. When lack of water, press (???), the heat will not start, it displays (⚡) on the screen. When plenty of water is filled, the pump start and it displays (💧) on the screen.
7. Sound  
when the system is startup, press (FM) the panel once start FM, the LCD displays current frequency; when the FM is startup, hold down (TUN/MEM) it will go up to search or memory the channel automatically, press (TUN/MEM) of the panel, the FM frequency shines, repress (+) or (-) to search the channel up or down manually. When the frequency stops shining, press (TUN/MEM) for the second time, the FM frequency shines, repress (+) or (-) the search the channel up and down, the frequency range is 0-19. Press (FM) of the panel, the system changes to CD, it will display "CD".
8. Adjustment of volume  
When the sound is startup, press (VOL) and then press (+) or (-) to adjust the volume of the sound, the LCD screen displays 0db-15db.
9. Automatic lock  
When the system is startup, if there is no operation within 3 minutes, the keys will be locked by the system automatically, hold (LOCK) for a while then the keys can be unlocked

1. The installation should be carried out by a qualified technician and creepage protector should be installed in the place easily to be controlled.
2. The electronic parts should be well grounded, otherwise, the manufacturer will not be liable for any loss or consequences occurred.
3. The load capability of the power supply should be considered during installation, or it affects the normal operation of the product or may lead to accident!
4. For any functions can not be activated through the ways mentioned above, please contact a certified technicians or local dealer.
5. If you don't use the product for a long time, please disconnect the main power supply.
6. Parts containing live parts, except parts supplied with safety extra-low voltage not exceeding 12V, must be inaccessible to a person in the bath.
7. Earthed appliances must be permanently connected to fixed wiring.
8. Parts incorporating electrical components, except remote control devices, must be located or fixed so that they cannot fall into the bath.
9. The appliance should be supplied through a residual current device (RCD) having a rated residual operating current not exceeding 30mA.
10. Make sure that the wire is laid correctly.
11. Make sure that the equipotential connection is done correctly.
12. The means having a contact at least 3.0mm separation in all poles that provide full disconnection must be incorporated in the fixed wiring in accordance with the wiring rules.
13. If the supply cord is damaged, it must be replaced by the manufacturer, its service agent or similarly qualified persons in order to avoid a hazard.



Earthing Marking



Equipotential



Switch Marking